

DESCRIPTION

The 30P06D uses advanced trench technology to provide excellent $R_{DS(ON)}$ and low gate charge. This device is suitable for use as a load switch or in PWM applications.

GENERAL FEATURES

$V_{DS} = -60V, I_D = -30A$

$R_{DS(ON)} < 40m\Omega @ V_{GS} = -10V$

$R_{DS(ON)} < 55m\Omega @ V_{GS} = -4.5V$

High Power and current handling capability

Lead free product is acquired

Surface Mount Package

Application

PWM applications

Load switch

Power management



TO252-2L

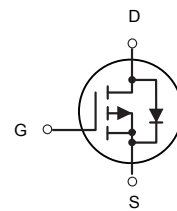

P-Channel MOSFET

ABSOLUTE MAXIMUM RATINGS(TA=25°C unless otherwise noted)

Parameter	Symbol	Limit	Unit
Drain-Source Voltage	V _{DS}	-60	V
Gate-Source Voltage	V _{GS}	±20	V
Drain Current-Continuous@ Current-Pulsed (Note 1)	I _D (25°C)	-30	A
	I _D (70°C)	-20	A
	I _{DM}	-60	A
Maximum Power Dissipation	P _D	60	W
Operating Junction and Storage Temperature Range	T _J , T _{STG}	-55 To 175	°C
Thermal Resistance, Junction-to-Ambient (Note 2)	R _{θJA}	25	°C/W

ELECTRICAL CHARACTERISTICS (TA=25°C unless otherwise noted)

Parameter	Symbol	Condition	Min	Typ	Max	Unit
Drain-Source Breakdown Voltage	BVDSS	V _{GS} =0V, I _D =-250μA	-60			V
Zero Gate Voltage Drain Current	I _{DSS}	V _{DS} =-48V, V _{GS} =0V			-1	μA
Gate-Body Leakage Current	I _{GSS}	V _{GS} =±20V, V _{DS} =0V			±100	nA
Gate Threshold Voltage	V _{GS(th)}	V _{DS} =V _{GS} , I _D =-250μA	-1	-1.8	-2.5	V
Drain-Source On-State Resistance	R _{DS(on)}	V _{GS} =-10V, I _D =-20A		31	40	mΩ
		V _{GS} =-4.5V, I _D =-20A		42	55	mΩ
Forward Transconductance	g _{FS}	V _{DS} =-5V, I _D =-20A	5			S
Input Capacitance	C _{iss}	V _{DS} =-30V, V _{GS} =0V, F=1.0MHz		3060		PF
Output Capacitance	C _{oss}			300		PF
Reverse Transfer Capacitance	C _{rss}			205		PF
Turn-on Delay Time	t _{d(on)}	V _{DS} =-30V, V _{GS} =-10V, R _{GEN} =3Ω I _D =1A		14		nS
Turn-on Rise Time	t _r			20		nS
Turn-Off Delay Time	t _{d(off)}			40		nS
Turn-Off Fall Time	t _f			19		nS
Total Gate Charge	Q _g	V _{DS} =-30V, I _D =-20A, V _{GS} =-10V		48		nC
Gate-Source Charge	Q _{gs}			11		nC
Gate-Drain Charge	Q _{gd}			10		nC
Body Diode Reverse Recovery Time	T _{rr}	I _F =-20A, dI/dt=100A/μs		40		nS
Body Diode Reverse Recovery Charge	Q _{rr}			56		nC
Diode Forward Voltage (Note 3)	V _{SD}	V _{GS} =0V, I _S =-1A		-0.72	-1	V

NOTES:

1. Repetitive Rating: Pulse width limited by maximum junction temperature.
2. Surface Mounted on 1in² FR4 Board, t ≤ 10 sec.
3. Pulse Test: Pulse Width ≤ 300μs, Duty Cycle ≤ 2%. 4. Guaranteed by design, not subject to production testing.

TYPICAL ELECTRICAL AND THERMAL CHARACTERISTICS

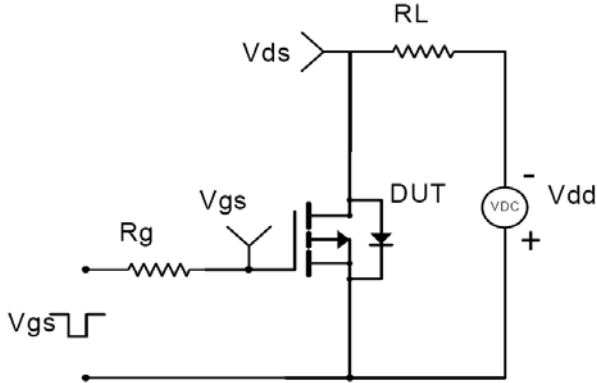

Figure 1: Switching Test Circuit

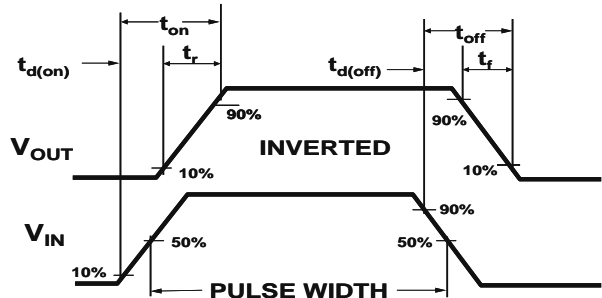

Figure 2: Switching Waveforms

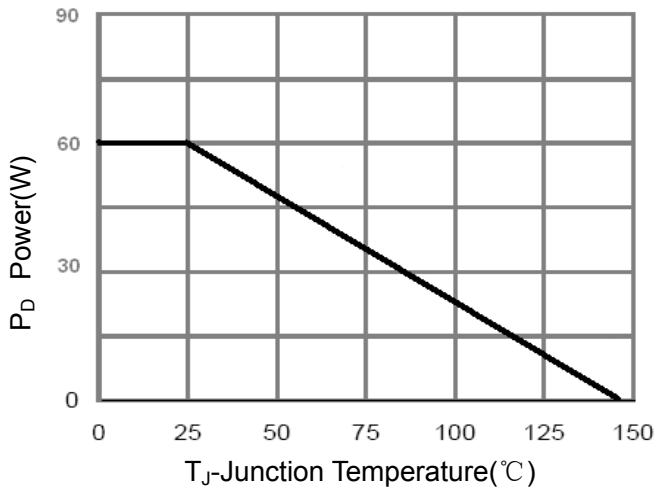

Figure 3 Power Dissipation

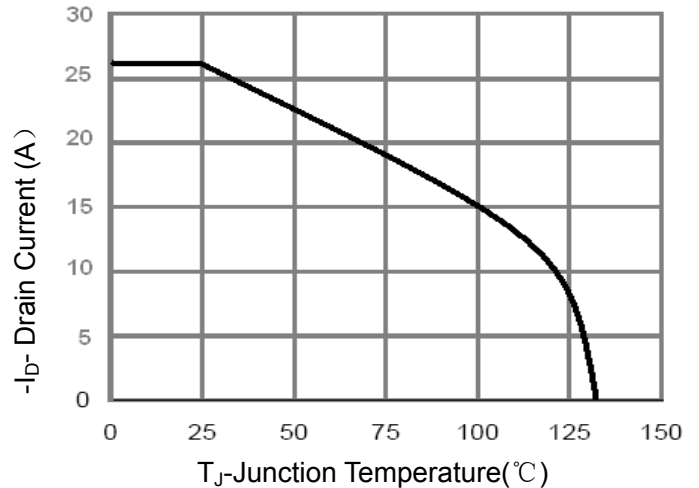

Figure 4 Drain Current

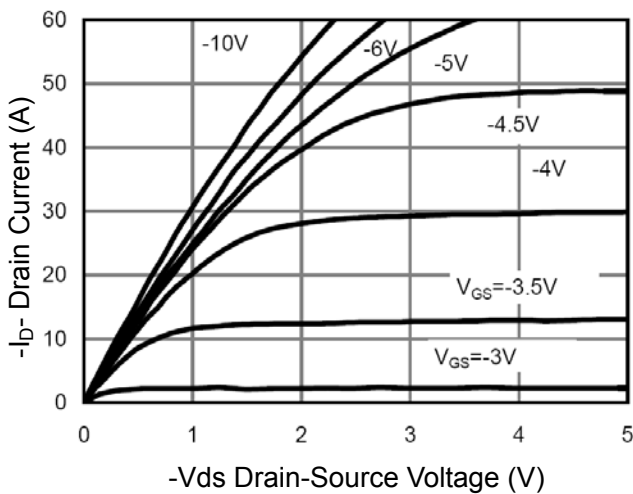

Figure 5 Output CHARACTERISTICS

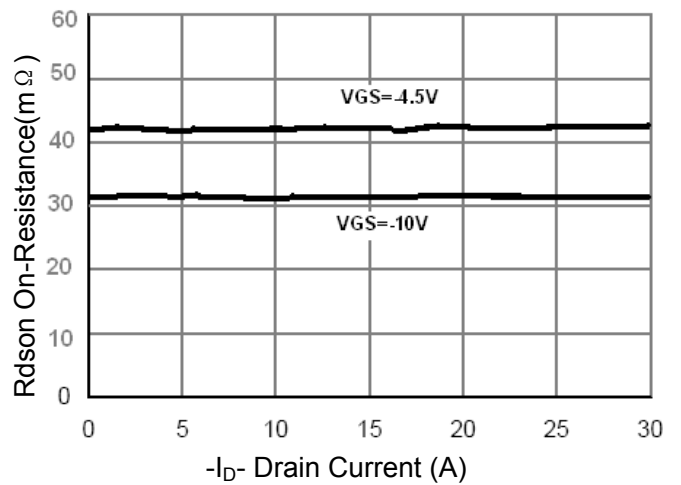

Figure 6 Drain-Source On-Resistance

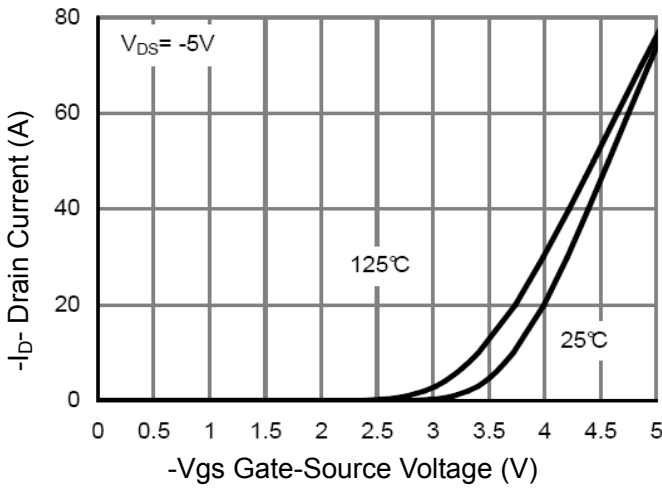

Figure 7 Transfer Characteristics

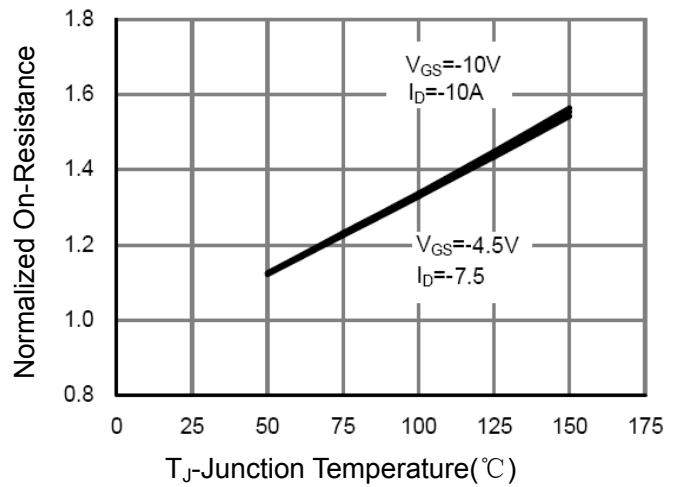

Figure 8 Drain-Source On-Resistance

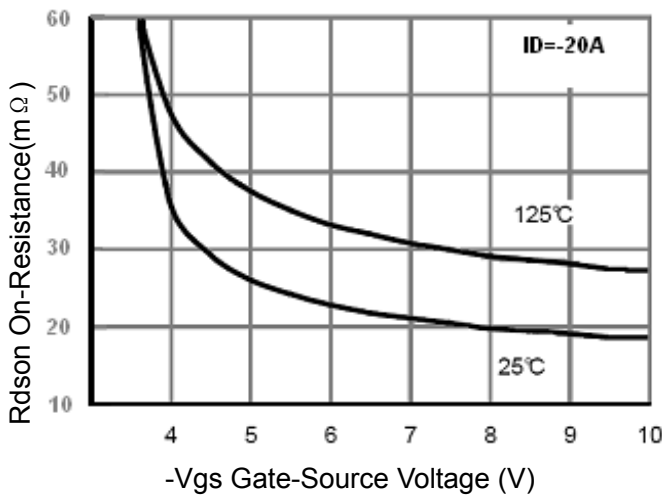

Figure 9 Rdson vs Vgs

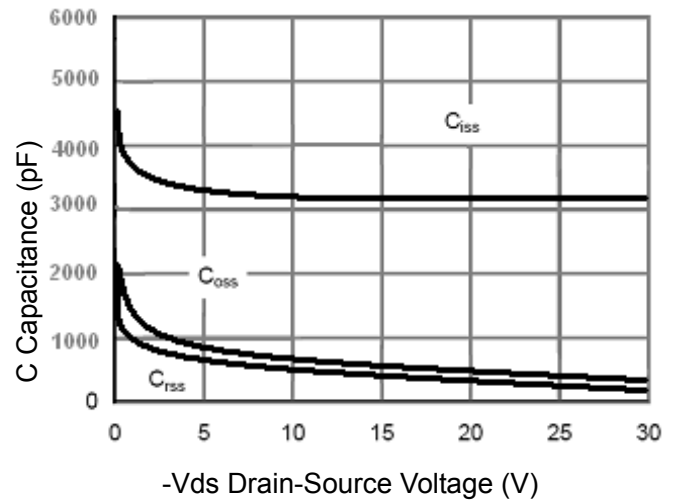

Figure 10 Capacitance vs Vds

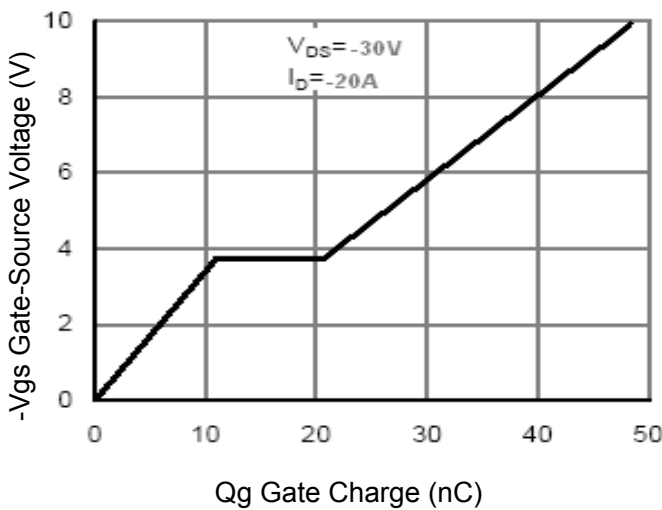

Figure 11 Gate Charge

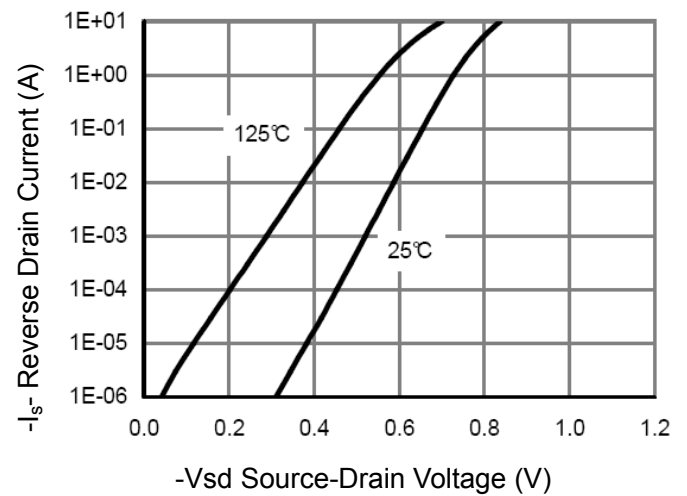

Figure 12 Source- Drain Diode Forward

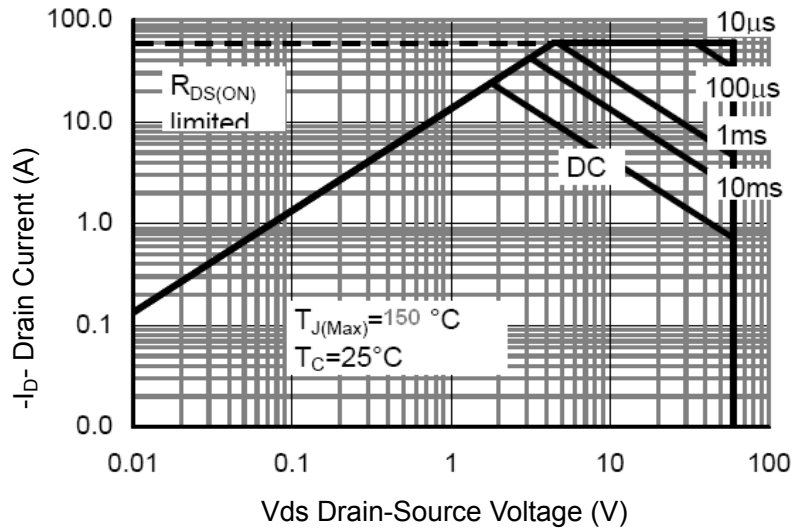

Figure 13 Safe Operation Area

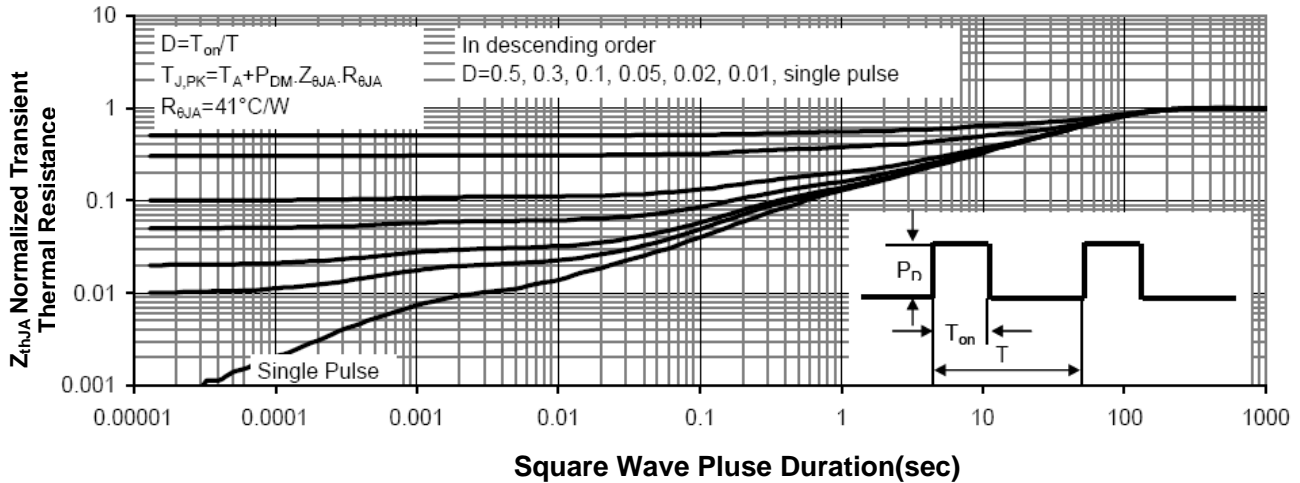
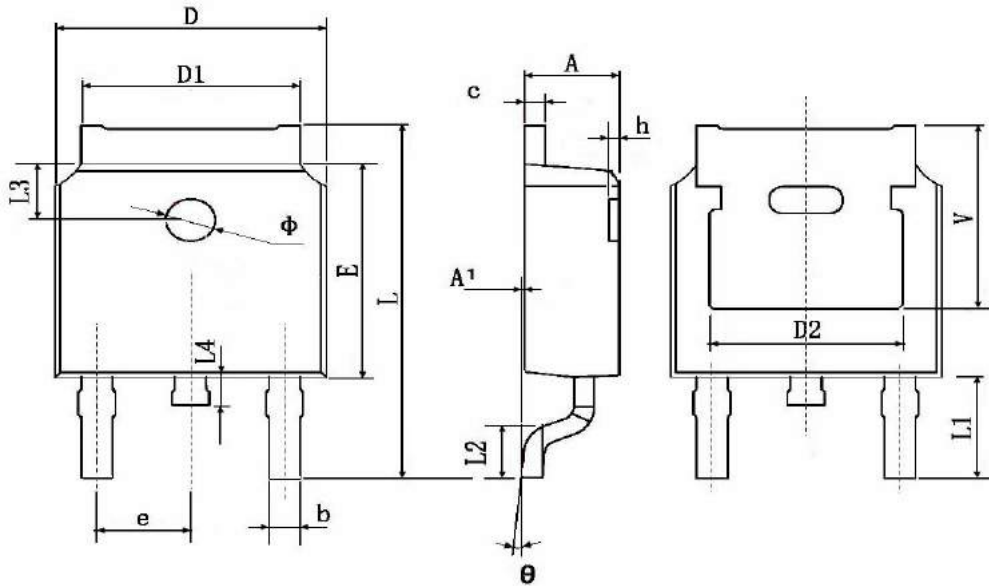

Figure 14 Normalized Maximum Transient Thermal Impedance

TO252-2L Package Information

Symbol	Dimensions In Millimeters		Dimensions In Inches	
	Min.	Max.	Min.	Max.
A	2.200	2.400	0.087	0.094
A1	0.000	0.127	0.000	0.005
b	0.660	0.860	0.026	0.034
c	0.460	0.580	0.018	0.023
D	6.500	6.700	0.256	0.264
D1	5.100	5.460	0.201	0.215
D2	4.830 TYP.		0.190 TYP.	
E	6.000	6.200	0.236	0.244
e	2.186	2.386	0.086	0.094
L	9.800	10.400	0.386	0.409
L1	2.900 TYP.		0.114 TYP.	
L2	1.400	1.700	0.055	0.067
L3	1.600 TYP.		0.063 TYP.	
L4	0.600	1.000	0.024	0.039
Φ	1.100	1.300	0.043	0.051
θ	0°	8°	0°	8°
h	0.000	0.300	0.000	0.012
V	5.350 TYP.		0.211 TYP.	